

# DOLOMITI



Civilization of Beauty

Gres porcellanato colorato in massa. Full-body coloured porcelain stoneware.  
Grès cérame coloré dans la masse. In der Masse gefärbtes Feinsteinzeug.  
Gres porcelánico coloreado en masa. Окрашенный по всей толщине керамогранит. 多彩陶器



# DOLOMITI

INDOOR . OUTDOOR

**Gres porcellanato colorato in massa.** Full-body coloured porcelain stoneware.  
Grès cérame coloré dans la masse. In der Masse gefärbtes Feinsteinzeug.  
Gres porcelánico coloreado en masa. Окрашенный по всей толщине керамогранит. 多彩陶瓷

## CALCITE . SABBIA . CENERE . BASALTO

60x120 (24"x48") 60x60 (24"x24") 30x60 (12"x24") 30,5x60,5 (12"x24") **10mm**  
**\*60x120 (24"x48") \*60x60 (24"x24") 30,5x60,5 (12"x24") R11 . 10mm**  
40x120 (16"x48") **R11 . 20mm**

**Liscio. Liscio lappato. Strutturato. Bocciardato.**  
Smooth. Smooth honed. Structured. Hammered finish.  
Lisse. Lisse semi poli. Structuré. Bouchardé.  
Glatt. Glatt teilpoliert. Strukturiert. Gehämmert.  
Liso. Liso lapeado. Estructurado. Abujardado.  
Гладкий. Гладкий полуполированный. Структурированный. Бучардированный.  
光滑的。光滑的打磨的。结构化的。波恰尔达多。

\* **Articolo disponibile per progetti (ordine minimo circa 1.500mq).** Article available for large-scale projects (minimum order: approximately 1.500 m<sup>2</sup>).  
Article disponible pour les projets (commande minimale environ 1.500 m<sup>2</sup>). Fuer Projekte verfügbare Artikel (Mindestbestellung ca. 1.500 qm).  
Artículo disponible para proyectos (pedido mínimo aproximadamente 1.500 m<sup>2</sup>). Этот артикул поставляет для крупных проектов (минимальный заказ – около 1.500 кв.м).  
计划产品 (最低预订量约1500平方米)

# DOLOMITI

## Gres porcellanato colorato in massa.

Full-body coloured porcelain stoneware.

Grès cérame coloré dans la masse.

In der Masse gefärbtes Feinsteinzeug.

Gres porcelánico coloreado en masa.

Окрашенный по всей толщине керамогранит. 多彩陶瓷

Dal granito delle Alpi dolomitiche **LA FABBRICA** ha tratto ispirazione per realizzare una collezione in gres porcellanato dall'anima intensa e materica, dove la funzionalità della ceramica si sposa in perfetto equilibrio con un'estetica ricercata e d'effetto.

La bellezza e la forza della catena montuosa dichiarata **Patrimonio Mondiale UNESCO** hanno fatto da musa alla serie declinata in quattro colorazioni neutre, numerose superfici e formati, anche di grandi dimensioni, e spessori ideali per ambienti indoor e outdoor, rendendo **Dolomiti** la scelta più indicata per l'architettura contemporanea.

**LA FABBRICA** se ha inspirado en el granito de los Alpes Dolomíticos para realizar una colección en gres porcelánico de alma intensa y matérica, en la cual la funcionalidad de la cerámica se combina en perfecto equilibrio con una estética refinada y de efecto.

La belleza y la fuerza de la cadena montuosa declarada **Patrimonio Mundial de la UNESCO** han actuado como musa de la serie, presentada en cuatro coloraciones neutras, numerosas superficies y formatos -incluso de grandes dimensiones- y espesores ideales para ambientes de interiores y exteriores, convirtiendo a **Dolomiti** en la opción más adecuada para la arquitectura contemporánea.

Inspired by the granite of the Dolomite mountains, **LA FABBRICA** has created a new porcelain stoneware collection with a dramatic, textured feel. The functional features of the ceramic material blend perfectly with the collection's sophisticated, high-impact aesthetics.

The beauty and strength of the mountain range declared a **UNESCO World Heritage** site provided inspiration for this series featuring four neutral colour shades, a vast assortment of surface finishes and sizes (including extra-large versions), and thicknesses that are suitable for both indoor and outdoor settings, making **Dolomiti** the ideal collection for contemporary architecture.

Гранит Доломитовых Альп вдохновил **LA FABBRICA** в создании коллекции керамогранита с выраженным и ярким характером, в которой функциональность керамики в полном равновесии сочетается с изысканным и впечатляющим внешним видом.

Красота и сила горной цепи, включенной в список объектов **всемирного наследия ЮНЕСКО**, воплотились в этой коллекции, предлагающей четыре нейтральных цвета, разнообразные отделки и форматы, в т.ч. крупноразмерные, и идеальную толщину для внутренних и наружных пространств. В результате всего этого **Dolomiti** является наилучшим выбором для проектов современной архитектуры.

**LA FABBRICA** s'inspire du granit des Dolomites pour réaliser une collection en grès cérame au caractère intense et matérialiste, où la fonctionnalité de la céramique se marie avec une esthétique raffinée et d'effet en un équilibre parfait.

La beauté et la force de la chaîne montagneuse déclarée **Patrimoine Mondiale UNESCO** sont les muses de la série déclinée en quatre colorations neutres, avec nombreuses surfaces et formats, également de grandes dimensions, et des épaisseurs idéales pour l'intérieur et l'extérieur, grâce auxquels la collection **Dolomiti** constitue le meilleur choix pour l'architecture contemporaine.

由多罗米蒂阿尔卑斯白云山 **LA FABBRICA** 获得了灵感以创制蕴含激情与灵魂的炻瓷系列，在此陶瓷的功能与精致美观和醒目效果达成完美的平衡。

作为世界遗产的山脉的魅力与力量，绵延着四种中性的色彩，拥有各种表面与形状，包括巨大的尺寸，具备室内外理想的厚度，使得多罗米蒂成为当代建筑最佳的选择。

Den Granit der dolomitischen Alpen hat **LA FABBRICA** zur Anregung genommen, um eine Kollektion von Feinsteinzeug mit einer tiefgründigen und materischen Seele herzustellen, bei der die Funktionalität der Keramik im perfekten Gleichgewicht zu einer auserlesenen und effektvollen Ästhetik steht.

Die Schönheit und Kraft der Bergkette, die zum **Welterbe UNESCO** erklärt wurde, waren die Muse für die in vier neutrale Färbungen, zahlreiche Oberflächen und Formate, auch von großen Abmessungen, und Stärken gegliederten Serie, die ideal für Räume Indoor und Outdoor sind und **Dolomiti** zur treffendsten Wahl für die zeitgenössische Architektur machen.

**La tecnologia ceramica Inkjet permette di realizzare un elevato numero di grafiche differenti, per un effetto estetico del pavimento e del rivestimento sempre vario e mai ripetitivo.**

The Inkjet ceramic technology allows a high number of different graphics, for an aesthetic effect of the flooring and cladding that is always varied and never repetitive.

La technologie céramique Inkjet, permet de réaliser un nombre élevé de rendus graphiques différents, en apportant ainsi un effet esthétique au revêtement de sol et aux autres revêtements, toujours varié et jamais répétitif.

Dank der Inkjet Keramiktechnologie kann man zahlreiche unterschiedliche Grafiken kreieren und für den Boden- und Wandbeläge vielfältige und einzigartige ästhetische Effekte erzielen.

La tecnología cerámica Inkjet permite realizar un elevado número de diferentes diseños gráficos, para un efecto estético del pavimento y del revestimiento siempre diferente y nunca repetitivo.

Технология Inkjet позволяет реализовать большое количество различных графических вариантов и обеспечить разнообразнейшее и всегда неповторимое эстетическое оформление пола или облицовки.

喷墨陶瓷技术能够实现大量的不同图案，产生良好的美学效果与永不重复的涂饰。

100% DESIGN  
AND PRODUCTION  
OF ITALY



Civilization of Beauty

**BASALTO 30**

**SABBIA 14**

**CENERE 22**

**CALCITE 6**

# UNA GAMMA COMPLETA PER L'INDOOR E L'OUTDOOR



Civilization of Beauty

## DOLOMITI

### Gres porcellanato colorato in massa.

Full-body coloured porcelain stoneware.

Grès cérame coloré dans la masse.

In der Masse gefärbtes Feinsteinzeug.

Gres porcelánico coloreado en masa.

Окрашенный по всей толщине керамогранит. 多彩陶瓷

FORMATO Format Format Formato	SPESSORE Thickness Épaisseur Dicken	LISCIO		LISCIO LAPPATO		BOCCIARDATO		STRUTTURATO R11 A+B+C	
		NATURALE	RETTIFICATO	NATURALE	RETTIFICATO	NATURALE	RETTIFICATO	NATURALE	RETTIFICATO
60x120 24"x48"	10 mm		●		●				●*
40x120 16"x48"	20 mm								●
60x60 24"x24"	10 mm		●		●				●*
30,5x60,5 12"x24"	10 mm	●				●		●	
30x60 12"x24"	10 mm		●		●			●	

\* Articolo disponibile per progetti (ordine minimo circa 1.500mq).

Article available for large-scale projects (minimum order: approximately 1.500 m<sup>2</sup>).

Article disponible pour les projets (commande minimale environ 1.500 m<sup>2</sup>).

Für Projekte verfügbare Artikel (Mindestbestellung ca. 1.500 qm).

Artículo disponible para proyectos (pedido mínimo aproximadamente 1.500 m<sup>2</sup>).

Этот артикул доступен для крупных проектов (минимальный заказ – около 1.500 кв.м.).

計量單位 (最低預訂量約1500平方米)

A complete range for indoor and outdoor use.  
Une gamme complète pour l'intérieur et l'extérieur.  
Eine vollständige Palette für Indoor und Outdoor.  
Una gama completa para interiores y exteriores.  
Полная гамма изделий для внутренних и наружных работ.  
室内室外的完整系列。

### STRUTTURATO

Structured . Structuré .  
Strukturiert . Estructurado .  
Структурированный . 结构化的 .

### BOCCIARDATO

Hammered finish . Bouchardé .  
Gehämmert . Abujardado .  
Бучардированная . 波恰尔多 .

### LISCIO LAPPATO

Smooth honed . Lisse semi poli .  
Glatt teilpoliert . Liso lapeado .  
Гладкая притертая . 光滑的打磨的 .

### LISCIO

Smooth . Lisse .  
Glatt . Liso .  
Гладкая . 光滑的 .

### Gres porcellanato colorato in massa.

Full-body coloured porcelain stoneware.

Grès cérame coloré dans la masse.

In der Masse gefärbtes Feinsteinzeug.

Gres porcelánico coloreado en masa.

Окрашенный по всей толщине керамогранит. 多彩陶瓷

Calcite 60x120 - 24" x 48" - Liscio Ret.

## CALCITE



Civilization of Beauty

Calcite 30,5x60,5 - 12" x 24" - Struc. Ret. RT

**CALCITE INDOOR & OUTDOOR**

Calcite 60x120 . 24"x48" Liscio Ret.  
Cenere Mosaico Bocciardato/Liscio 30x30 . 12"x12"  
Calcite Mosaico Bocciardato/Liscio 30x30 . 12"x12"  
Calcite 50,5x60,5 . 12"x24" Strut. Nat. R11



**CALCITE**

Calcite 60x60 . 24"x24" Liscio Ret.



Calcite 60x120 . 24"x48" Liscio Ret.  
Cenere Mosaico Bocciardato/Liscio 30x30 . 12"x12"  
Calcite Mosaico Bocciardato/Liscio 30x30 . 12"x12"



**CALCITE OUTDOOR**

Calcite 30,5x60,5 . 12"x24" Strut. Nat. R11

**Gres porcellanato colorato in massa.**  
Full-body coloured porcelain stoneware.  
Grès cérame coloré dans la masse.  
In der Masse gefärbtes Feinsteinzeug.  
Gres porcelánico coloreado en masa.  
Окрашенный по всей толщине керамогранит. 多彩陶瓷

Sabbia 60x120 . 24" x48" Bocciardato Ret.

# SABBIA



Civilization of Beauty

Sabbia 60x120 . 24" x48" Liseto Ret.





**SABBIA**

Sabbia 60x120 . 24"x48" Bocciardato Ret.  
Sabbia Mosaico Bocciardato/Liscio 30x30 . 12"x12"  
Sabbia 30x60 . 12"x24" Liscio Ret.





**SABBIA**

Sabbia 50x60 . 12"x24" Liscio Ret.

Sabbia 60x120 . 24"x48" Bocciardato Ret.

Sabbia Mosaico Bocciardato/Liscio 30x30 . 12"x12"





**SABBIA**

Sabbia 60x120 . 24"x48" Liscio Ret.

**Gres porcellanato colorato in massa.**  
Full-body coloured porcelain stoneware.  
Grès cérame coloré dans la masse.  
In der Masse gefärbtes Feinsteinzeug.  
Gres porcelánico coloreado en masa.  
Окрашенный по всей толщине керамогранит. 多彩陶瓷

# CENERE



CenerE 40x120 - 16" x48" Strut. Ret. R11 20mm

CenerE 60x120 - 24"x48" Liscio Lap. Ret.





**CENERE**

Cenere 60x120 . 24"x48" Liscio Lap. Ret.



**CENERE**

Cenere 60x120 - 24"x48" Liscio Lap. Ret.

CENERE OUTDOOR 20mm  
Cenere 40x120 . 16"x48" Strut. Ret. R11 20mm



**Gres porcellanato colorato in massa.**  
Full-body coloured porcelain stoneware.  
Grès cérame coloré dans la masse.  
In der Masse gefärbtes Feinsteinzeug.  
Gres porcelánico coloreado en masa.  
Окрашенный по всей толщине керамогранит. 多彩陶瓷

# BASALTO

Basalto 60x120 - 24"x48" Bocc. Ret.



Basalto 30,5x60,5 - 12"x24" Liscio Nat.





**BASALTO**

Basalto 30,5x60,5 . 12"x24" Liscio Nat.



**BASALTO**

Basalto 60x120 . 24"x48" Liscio Lap. Ret.



**BASALTO OUTDOOR**  
Basalto 60x120 . 24"x48" Bocciardato Ret.



# DOLOMITI

**Gres porcellanato colorato in massa.** Full-body colored porcelain stoneware. Grès cérame coloré dans la masse. In der Masse gefärbtes Feinsteinzeug. Gres porcelánico coloreado en masa. Окрашенный по всей толщине керамогранит. 多彩陶瓷

INDOOR - OUTDOOR

**Spessore.** Thickness. Epaisseur. Stärke. Espesor. Толщина. 层. **10 mm**

**60x120 (24"x48") . 60x60 (24"x24") . 30x60 (12"x24") . 30,5x60,5 (12"x24")**

- ☆ **Liscio e rettificato.** Smooth and rectified. Lisse et rectifié. Glatt und kalibriert. Liso y rectificado. Гладкий Ректифицированный. 光滑修正的
- ★ **Liscio e naturale.** Smooth and natural. Lisse et naturel. Glatt und natur. Liso y natural. Гладкий Натуральный. 光滑天然的
- **Liscio lappato e rettificato.** Smooth honed and rectified. Lisse semi poli et rectifié. Glatt teilpoliert und kalibriert. Liso, lareado y rectificado. Гладкий Полуполированный Ректифицированный. 打磨光滑修正的
- ▽ **Strutturato rettificato.** Structured rectified. Structuré rectifié. Strukturiert kalibriert. Estructurado rectificado. Структурированный Ректифицированный. 修正结构化的
- ▼ **Strutturato naturale.** Natural structured. Naturel structuré. Natur strukturiert. Natural estructurado. Структурированный Натуральный. 天然结构化的
- △ **Bocciardato rettificato.** Rectified bush-hammered finish. Bouchardé rectifié. Gehämmert, kalibriert. Abujardado rectificado. Бучардированный Ректифицированный. 修正波恰尔达多
- ▲ **Bocciardato naturale.** Natural bush-hammered finish. Bouchardé naturel. Gehämmert, natur. Abujardado natural. Бучардированный Натуральный. 修正波恰尔达多



SHADE SPECTRUM	<input type="checkbox"/> Low	<input checked="" type="checkbox"/> Moderate	ANSI A 137.1: 2012	OUTDOOR A+B+C
	<input type="checkbox"/> High	<input type="checkbox"/> Random	WET DYNAMIC COEFFICIENT OF FRICTION	<b>R11</b>
			<b>DCOF &gt; 0,42</b>	SCIVOLOSITÀ SLIPPERY GRADE



Civilization of Beauty

## CALCITE



- B190 086001** Calcite  
60x120 . 24"x48" Liscio. Ret. ☆
- B190 086002** Calcite  
60x120 . 24"x48" Bocciardato Ret. △
- B253 086003** Calcite  
60x120 . 24"x48" Liscio Lap. Ret. ○
- B190 086004** Calcite  
60x120 . 24"x48" Strut. Ret. ▼ **R11** \*



- B140 086041** Calcite  
60x60 . 24"x24" Liscio. Ret. ☆
- B140 086042** Calcite  
60x60 . 24"x24" Bocciardato Ret. △
- B225 086043** Calcite  
60x60 . 24"x24" Liscio Lap. Ret. ○
- B140 086044** Calcite  
60x60 . 24"x24" Strut. Ret. ▼ **R11** \*

## SABBIA



- B190 086007** Sabbia  
60x120 . 24"x48" Liscio. Ret. ☆
- B190 086008** Sabbia  
60x120 . 24"x48" Bocciardato Ret. △
- B253 086009** Sabbia  
60x120 . 24"x48" Liscio Lap. Ret. ○
- B190 086010** Sabbia  
60x120 . 24"x48" Strut. Ret. ▼ **R11** \*



- B140 086047** Sabbia  
60x60 . 24"x24" Liscio. Ret. ☆
- B140 086048** Sabbia  
60x60 . 24"x24" Bocciardato Ret. △
- B225 086049** Sabbia  
60x60 . 24"x24" Liscio Lap. Ret. ○
- B140 086050** Sabbia  
60x60 . 24"x24" Strut. Ret. ▼ **R11** \*

## CENERE



- B190 086013** Cenere  
60x120 . 24"x48" Liscio. Ret. ☆
- B190 086014** Cenere  
60x120 . 24"x48" Bocciardato Ret. △
- B253 086015** Cenere  
60x120 . 24"x48" Liscio Lap. Ret. ○
- B190 086016** Cenere  
60x120 . 24"x48" Strut. Ret. ▼ **R11** \*



- B140 086053** Cenere  
60x60 . 24"x24" Liscio. Ret. ☆
- B140 086054** Cenere  
60x60 . 24"x24" Bocciardato Ret. △
- B225 086055** Cenere  
60x60 . 24"x24" Liscio Lap. Ret. ○
- B140 086056** Cenere  
60x60 . 24"x24" Strut. Ret. ▼ **R11** \*

## BASALTO



- B190 086019** Basalto  
60x120 . 24"x48" Liscio. Ret. ☆
- B190 086020** Basalto  
60x120 . 24"x48" Bocciardato Ret. △
- B253 086021** Basalto  
60x120 . 24"x48" Liscio Lap. Ret. ○
- B190 086022** Basalto  
60x120 . 24"x48" Strut. Ret. ▼ **R11** \*



- B140 086059** Basalto  
60x60 . 24"x24" Liscio. Ret. ☆
- B140 086060** Basalto  
60x60 . 24"x24" Bocciardato Ret. △
- B225 086061** Basalto  
60x60 . 24"x24" Liscio Lap. Ret. ○
- B140 086062** Basalto  
60x60 . 24"x24" Strut. Ret. ▼ **R11** \*

## CALCITE



- B80 086101** Calcite  
30x60 . 12"x24" Liscio. Ret. ☆
- B80 086102** Calcite  
30x60 . 12"x24" Bocciardato Ret. △
- B225 086103** Calcite  
30x60 . 12"x24" Liscio Lap. Ret. ○
- B50 086071** Calcite  
30,5x60,5 . 12"x24" Liscio Nat. ★
- B50 086072** Calcite  
30,5x60,5 . 12"x24" Bocciardato Nat. ▲
- B50 086073** Calcite  
30,5x60,5 . 12"x24" Strut. Nat. ▼ **R11**

## SABBIA



- B80 086107** Sabbia  
30x60 . 12"x24" Liscio. Ret. ☆
- B80 086108** Sabbia  
30x60 . 12"x24" Bocciardato Ret. △
- B225 086109** Sabbia  
30x60 . 12"x24" Liscio Lap. Ret. ○
- B50 086077** Sabbia  
30,5x60,5 . 12"x24" Liscio Nat. ★
- B50 086078** Sabbia  
30,5x60,5 . 12"x24" Bocciardato Nat. ▲
- B50 086079** Sabbia  
30,5x60,5 . 12"x24" Strut. Nat. ▼ **R11**

## CENERE



- B80 086111** Cenere  
30x60 . 12"x24" Liscio. Ret. ☆
- B80 086112** Cenere  
30x60 . 12"x24" Bocciardato Ret. △
- B225 086113** Cenere  
30x60 . 12"x24" Liscio Lap. Ret. ○
- B50 086083** Cenere  
30,5x60,5 . 12"x24" Liscio Nat. ★
- B50 086084** Cenere  
30,5x60,5 . 12"x24" Bocciardato Nat. ▲
- B50 086085** Cenere  
30,5x60,5 . 12"x24" Strut. Nat. ▼ **R11**

## BASALTO

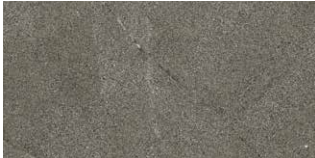

- B80 086117** Basalto  
30x60 . 12"x24" Liscio. Ret. ☆
- B80 086118** Basalto  
30x60 . 12"x24" Bocciardato Ret. △
- B225 086119** Basalto  
30x60 . 12"x24" Liscio Lap. Ret. ○
- B50 086089** Basalto  
30,5x60,5 . 12"x24" Liscio Nat. ★
- B50 086090** Basalto  
30,5x60,5 . 12"x24" Bocciardato Nat. ▲
- B50 086091** Basalto  
30,5x60,5 . 12"x24" Strut. Nat. ▼ **R11**

**Mosaici.** Mosaic. Mosaïque. Mosaik. Mosaico. Мозаика. 马赛克.

### Mosaico Bocciardato/Lappato

- |  |  |  |
|--|--|--|
|  | <b>B275 086155</b> Mosaico Calcite (Tessere 5x5)<br>30x30 . 12"x12" Bocc./Lap. | <b>B275 086157</b> Mosaico Cenere (Tessere 5x5)<br>30x30 . 12"x12" Bocc./Lap.  |
|  | <b>B275 086156</b> Mosaico Sabbia (Tessere 5x5)<br>30x30 . 12"x12" Bocc./Lap.  | <b>B275 086158</b> Mosaico Basalto (Tessere 5x5)<br>30x30 . 12"x12" Bocc./Lap. |

### Mosaico Bocciardato/Liscio

- |  |  |  |
|--|--|--|
|  | <b>B275 086165</b> Mosaico Calcite (Tessere 5x5)<br>30x30 . 12"x12" Bocc./Liscio | <b>B275 086167</b> Mosaico Cenere (Tessere 5x5)<br>30x30 . 12"x12" Bocc./Liscio  |
|  | <b>B275 086166</b> Mosaico Sabbia (Tessere 5x5)<br>30x30 . 12"x12" Bocc./Liscio  | <b>B275 086168</b> Mosaico Basalto (Tessere 5x5)<br>30x30 . 12"x12" Bocc./Liscio |

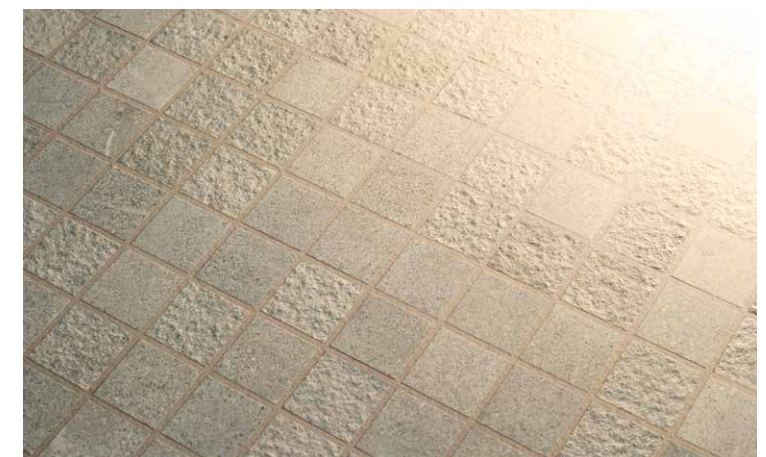

\* Articolo disponibile per progetti (ordine minimo circa 1.500mq). Article available for large-scale projects (minimum order: approximately 1.500 m<sup>2</sup>). Article disponible pour les projets (commande minimale environ 1.500 m<sup>2</sup>). Für Projekte verfügbarer Artikel (Mindestbestellung ca. 1.500 qm). Artículo disponible para proyectos (pedido mínimo aproximadamente 1.500 m<sup>2</sup>). Этот артикул подготавливается для крупных проектов (минимальный заказ – около 1.500 кв.м.). 计划产品 (最低预订量约1500平方米)

# DOLOMITI INDOOR - OUTDOOR

**Gres porcellanato colorato in massa.** Full-body coloured porcelain stoneware. Grès cérame coloré dans la masse. In der Masse gefärbtes Feinsteinzeug. Gres porcelánico coloreado en masa. Окрашенный по всей толщине керамогранит. 多彩陶瓷



**Spessore.** Thickness. Epaisseur. Stärke. Espesor. Толщина. 层. **10 mm**

- ☆ **Liscio e rettificato.** Smooth and rectified. Lisse et rectifié. Glatt und kalibriert. Liso y rectificado. Гладкий Ректифицированный. 光滑修正的
- ★ **Liscio e naturale.** Smooth and natural. Lisse et naturel. Glatt und natur. Liso y natural. Гладкий Натуральный. 光滑天然的
- **Liscio lappato e rettificato.** Smooth honed and rectified. Lisse semi poli et rectifié. Glatt teilpoliert und kalibriert. Liso, lareado y rectificado. Гладкий Полуполированный Ректифицированный. 打磨光滑修正的
- ▽ **Strutturato rettificato.** Structured rectified. Structuré rectifié. Strukturiert kalibriert. Estructurado rectificado. Структурированный Ректифицированный. 修正结构化的
- ▼ **Strutturato naturale.** Natural structured. Naturel structuré. Natur strukturiert. Natural estructurado. Структурированный Натуральный. 天然结构化的
- △ **Bocciardato rettificato.** Rectified bush-hammered finish. Bouchardé rectifié. Gehämmert, kalibriert. Abujardado rectificado. Бучардированный Ректифицированный. 修正波恰尔达多
- ▲ **Bocciardato naturale.** Natural bush-hammered finish. Bouchardé naturel. Gehämmert, natur. Abujardado natural. Бучардированный Натуральный. 修正波恰尔达多

**Pezzi speciali.** Trims. Pièces spéciales. Formstücke. Piezas especiales. Специальные Элементы. 特殊块



**BATTISCOPIA**  
9,5x60 . 3 3/4"x24" Liscio. Ret. ☆

- V134 086175 Calcite
- V134 086181 Sabbia
- V134 086187 Cenere
- V134 086193 Basalto



**BATTISCOPIA**  
9,5x60 . 3 3/4"x24" Liscio Lap. Ret. ○

- V140 086177 Calcite
- V140 086183 Sabbia
- V140 086189 Cenere
- V140 086195 Basalto



**BATTISCOPIA**  
9,5x60 . 3 3/4"x24" Bocciardato Ret. △

- V134 086176 Calcite
- V134 086182 Sabbia
- V134 086188 Cenere
- V134 086194 Basalto

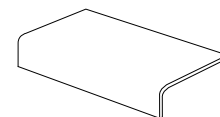

**ELEMENTO A "L"**  
16x30,5x4,5h . 6 1/4"x12"x1 3/4"h Strut. Nat. ▼ R11

- V200 086207 Calcite
- V200 086208 Sabbia
- V200 086209 Cenere
- V200 086210 Basalto

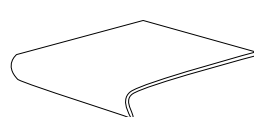

**GRADINO PIEGATO**  
30,5x34x5h . 12"x13 1/2"x2"h Strut. Nat. ▼ R11

- V280 086201 Calcite
- V280 086202 Sabbia
- V280 086203 Cenere
- V280 086204 Basalto

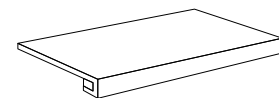

**GRADINO COSTA RETTA \*\***  
33x120x3,2 . 13"x48"x1 1/4"  
33x60x3,2 . 13"x24"x1 1/4"

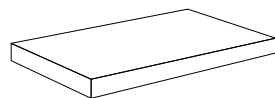

**GRADINO COSTA RETTA ANGOLO SX \*\***  
33x120x3,2 . 13"x48"x1 1/4"  
33x60x3,2 . 13"x24"x1 1/4"

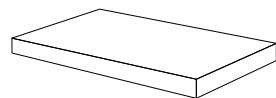

**GRADINO COSTA RETTA ANGOLO DX \*\***  
33x120x3,2 . 13"x48"x1 1/4"  
33x60x3,2 . 13"x24"x1 1/4"

	Gradino costa retta 33x120x3,2	Gradino costa retta Ang. DX 33x120x3,2	Gradino costa retta Ang. SX 33x120x3,2	Gradino costa retta 33x60x3,2	Gradino costa retta Ang. DX 33x60x3,2	Gradino costa retta Ang. SX 33x60x3,2
Liscio. Ret. ☆	V410 ✓	V428 ✓	V428 ✓	V377 ✓	V392 ✓	V392 ✓
Liscio Lap. Ret. ○	V410 ✓	V428 ✓	V428 ✓	V377 ✓	V392 ✓	V392 ✓
Bocciardato Ret. △	V410 ✓	V428 ✓	V428 ✓	V377 ✓	V392 ✓	V392 ✓

\*\*  
A disposizione solo su richiesta. Tempi di consegna: 30gg.  
Available upon request only. Delivery terms: 30 days. Disponible seulement sur requête. Délais de livraison: 30 jours. Verfügbar auf Anfrage. Lieferzeit: 30 Tage.  
Disponibile sólo bajo pedido. Plazo de entrega: 30 días. Изготавливается только по специальной заявке. Срок поставки: 30 дней. 仅按需供给。交付时间: 30日

Per il gradino non si garantisce la stessa tonalità del fondo.  
We cannot guarantee that the shade of the stair tile will be the same as the background tile. Pour la marche, nous ne garantissons pas la même tonalité du fond. Für die Stufe wird nicht der gleiche Farbton des Untergrunds garantiert. Para el peldaño no se garantiza el mismo tono del fondo. Для ступени не гарантирована одинаковость тона с фоном. 对于台阶不保证底色一致

# DOLOMITI OUTDOOR 20mm

**Gres porcellanato colorato in massa.** Full-body coloured porcelain stoneware. Grès cérame coloré dans la masse. In der Masse gefärbtes Feinsteinzeug. Gres porcelánico coloreado en masa. Окрашенный по всей толщине керамогранит. 多彩陶瓷



**Spessore.** Thickness. Epaisseur. Stärke. Espesor. Толщина. 层. **20 mm R11 A+B+C**

40x120 (16"x48")

▽ **Strutturato rettificato.** Structured rectified. Structuré rectifié. Strukturiert kalibriert. Estructurado rectificado. Структурированный ректифицированный. 修正结构化的

SHADE SPECTRUM

Low

Moderate

High

Random

ANSI A 137.1: 2012	OUTDOOR A+B+C
WET DYNAMIC COEFFICIENT OF FRICTION	R11
DCOF > 0,42	SCIVOLITÀ SLIPPERY GRADE

CALCITE  
20 mm



B259 086031 Calcite  
40x120 . 16"x48" 20mm  
Strut. Ret. ▼ R11

SABBIA  
20 mm



B259 086032 Sabbia  
40x120 . 16"x48" 20mm  
Strut. Ret. ▼ R11

CENERE  
20 mm



B259 086033 Cenere  
40x120 . 16"x48" 20mm  
Strut. Ret. ▼ R11

BASALTO  
20 mm



B259 086034 Basalto  
40x120 . 16"x48" 20mm  
Strut. Ret. ▼ R11

**Pezzi speciali.** Trims. Pièces spéciales. Formstücke. Piezas especiales. Специальные элементы. 特殊块

## SWIMMINGPOOL & OUTDOOR 20 mm - R11 A+B+C

▽ **Strutturato rettificato.** Structured rectified. Structuré rectifié. Strukturiert kalibriert. Estructurado rectificado. Структурированный ректифицированный. 修正结构化的

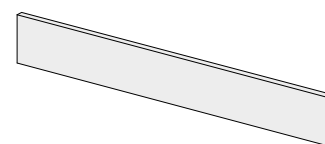

**ALZATA** V325  
20x120 . 8"x48" Strut. Ret. ▼  
086215 Calcite  
086216 Sabbia  
086217 Cenere  
086218 Basalto

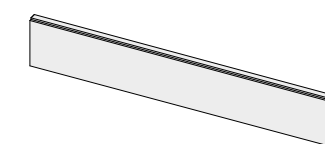

**ALZATA CON SCURETTO** V380  
20x120 . 8"x48" Strut. Ret. ▼  
086221 Calcite  
086222 Sabbia  
086223 Cenere  
086224 Basalto

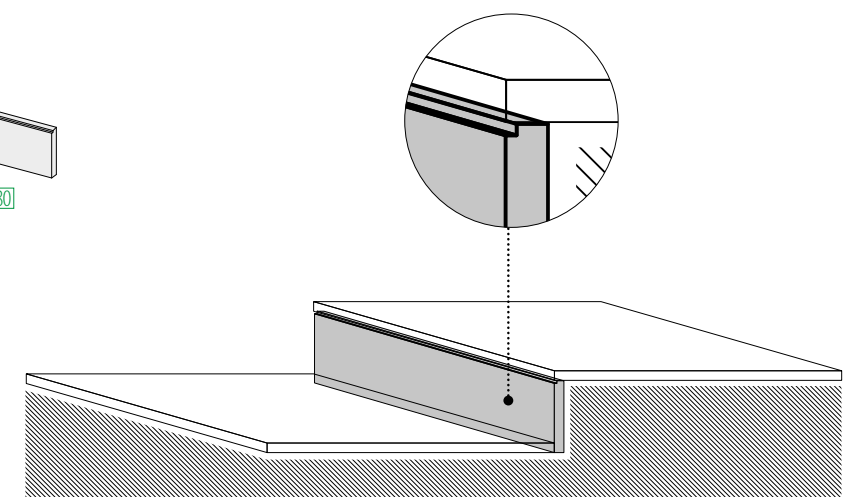

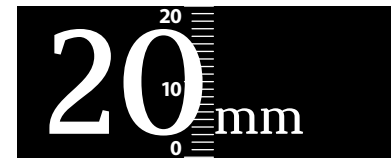

SHADE SPECTRUM	Low	Moderate	ANSI A 137.1: 2012	OUTDOOR A+B+C	
	High	Random			
	WET DYNAMIC COEFFICIENT OF FRICTION				R11
	DCOF > 0,42				

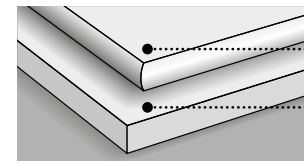

**Costa toro** . Bullnose edge . Bord boudin . Abgerundete Kante .

**Costa retta** . Straight edge . Bord droit . Gerade Kante .

▽ **Strutturato rettificato**. Structured rectified. Structuré rectifié. Strukturiert kalibriert. Estructurado rectificado. Структурированный ректифицированный. 修正结构化的



Civilization of Beauty

**A BORDO L "A" V397**  
10x120x10h . 4"x48"x4"h Strut. Ret. ▽  
086389 Calcite  
086390 Sabbia  
086391 Cenere  
086392 Basalto

**B BORDO L "A" - DX V415**  
10x120x10h . 4"x48"x4"h Strut. Ret. ▽  
086395 Calcite  
086396 Sabbia  
086397 Cenere  
086398 Basalto

**C BORDO L "A" - SX V415**  
10x120x10h . 4"x48"x4"h Strut. Ret. ▽  
086401 Calcite  
086402 Sabbia  
086403 Cenere  
086404 Basalto

**A CANALINA V438**  
20x120x8h . 8"x48"x3"h Strut. Ret. ▽  
086335 Calcite  
086336 Sabbia  
086337 Cenere  
086338 Basalto

**B CANALINA DX V450**  
20x120x8h . 8"x48"x3"h Strut. Ret. ▽  
086341 Calcite  
086342 Sabbia  
086343 Cenere  
086344 Basalto

**C CANALINA SX V450**  
20x120x8h . 8"x48"x3"h Strut. Ret. ▽  
086347 Calcite  
086348 Sabbia  
086349 Cenere  
086350 Basalto

**A BORDO L "B" V438**  
10x120x10h . 4"x48"x4"h Strut. Ret. ▽  
086407 Calcite  
086408 Sabbia  
086409 Cenere  
086410 Basalto

**B BORDO L "B" - DX V462**  
10x120x10h . 4"x48"x4"h Strut. Ret. ▽  
086413 Calcite  
086414 Sabbia  
086415 Cenere  
086416 Basalto

**C BORDO L "B" - SX V462**  
10x120x10h . 4"x48"x4"h Strut. Ret. ▽  
086419 Calcite  
086420 Sabbia  
086421 Cenere  
086422 Basalto

**A GRIGLIA 20 V400**  
20x60 . 8"x24" Strut. Ret. ▽  
086353 Calcite  
086354 Sabbia  
086355 Cenere  
086356 Basalto

**B GRIGLIA 20 - DX V400**  
20x60 . 8"x24" Strut. Ret. ▽  
086359 Calcite  
086360 Sabbia  
086361 Cenere  
086362 Basalto

**C GRIGLIA 20 - SX V400**  
20x60 . 8"x24" Strut. Ret. ▽  
086365 Calcite  
086366 Sabbia  
086367 Cenere  
086368 Basalto

**A CORDOLO V480**  
13x120x13h . 5"x48"x5"h Strut. Ret. ▽  
086371 Calcite  
086372 Sabbia  
086373 Cenere  
086374 Basalto

**B CORDOLO DX V500**  
13x120x13h . 5"x48"x5"h Strut. Ret. ▽  
086377 Calcite  
086378 Sabbia  
086379 Cenere  
086380 Basalto

**B CORDOLO SX V500**  
13x120x13h . 5"x48"x5"h Strut. Ret. ▽  
086383 Calcite  
086384 Sabbia  
086385 Cenere  
086386 Basalto

**A GRADONE BORDO 40**  
40x120 . 16"x48" Strut. Ret. ▽  
Costa retta V397  
086227 Calcite  
086228 Sabbia  
086229 Cenere  
086230 Basalto

**B GRADONE BORDO 40 - DX**  
40x120 . 16"x48" Strut. Ret. ▽  
Costa retta V410  
086239 Calcite  
086240 Sabbia  
086241 Cenere  
086242 Basalto

**C GRADONE BORDO 40 - SX**  
40x120 . 16"x48" Strut. Ret. ▽  
Costa retta V410  
086251 Calcite  
086252 Sabbia  
086253 Cenere  
086254 Basalto

**A GRADONE BORDO SVASATO**  
40x120 . 16"x48" Strut. Ret. ▽  
Costa retta V492  
086299 Calcite  
086300 Sabbia  
086301 Cenere  
086302 Basalto

**B GRADONE BORDO SVASATO - DX**  
40x120 . 16"x48" Strut. Ret. ▽  
Costa retta V500  
086311 Calcite  
086312 Sabbia  
086313 Cenere  
086314 Basalto

**C GRADONE BORDO SVASATO - SX**  
40x120 . 16"x48" Strut. Ret. ▽  
Costa retta V500  
086323 Calcite  
086324 Sabbia  
086325 Cenere  
086326 Basalto

**A GRADONE BORDO GRIP**  
40x120 . 16"x48" Strut. Ret. ▽  
Costa retta V410  
086263 Calcite  
086264 Sabbia  
086265 Cenere  
086266 Basalto

**B GRADONE BORDO GRIP - DX**  
40x120 . 16"x48" Strut. Ret. ▽  
Costa retta V425  
086275 Calcite  
086276 Sabbia  
086277 Cenere  
086278 Basalto

**C GRADONE BORDO GRIP - SX**  
40x120 . 16"x48" Strut. Ret. ▽  
Costa retta V425  
086287 Calcite  
086288 Sabbia  
086289 Cenere  
086290 Basalto

Gres porcellanato colorato in massa. Full-body coloured porcelain stoneware. Grès cérame coloré dans la masse. In der Masse gefärbtes Feinsteinzeug. Gres porcelánico coloreado en masa. Окрашенный по всей толщине керамогранит. 多彩陶瓷

Spessore. Thickness. Epaisseur. Stärke. Espesor. Толщина. 层. **20 mm R11 A+B+C**

### IL SUPPORTO FISSO

Fixed pedestals. Le plot fixe. Fixhalterung.



**201011**  
Supporto Fisso 15

V30 = 4 pcs



Ø 110 mm  
**201013** V30 = 4 pcs

Spessore-livellatore in gomma: 3 mm  
Rubber levelling shims: 3 mm  
Cale-correcteur de pente en caoutchouc: 3 mm  
Stärke des Nivellierers aus Gummi: 3 mm



Ø 110 mm  
**201012** V30 = 4 pcs

Spessore-livellatore in gomma: 2 mm  
Rubber levelling shims: 2 mm  
Cale-correcteur de pente en caoutchouc: 2 mm  
Stärke des Nivellierers aus Gummi: 2 mm

### IL SUPPORTO REGOLABILE

Adjustable pedestals. Le plot réglable. Regelbare Stütze.

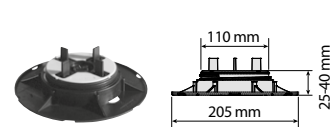

**201006**  
Supporto regolabile  
Adjustable paving support  
mm 25/40

V110

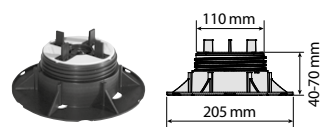

**201007**  
Supporto regolabile  
Adjustable paving support  
mm 40/70

V130

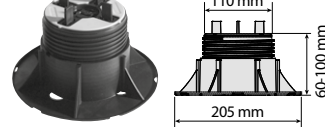

**201008**  
Supporto regolabile  
Adjustable paving support  
mm 60/100

V134

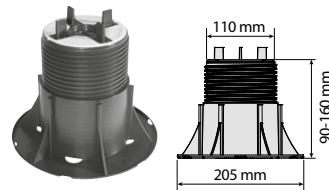

**201009**  
Supporto regolabile  
Adjustable paving support  
mm 90/160

V143

### IL SUPPORTO REGOLABILE AUTOLIVELLANTE

Self-levelling adjustable pedestals. Le plot réglable auto-nivelant. Regelbare, selbstnivellierende Stütze.

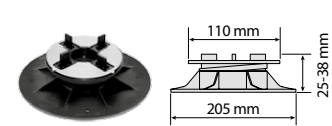

**201001**  
Supporto regolabile autolivellante  
Adjustable paving support  
self leveling head  
mm 28/38

V134

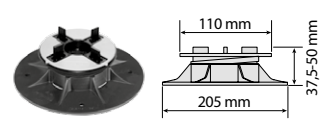

**201002**  
Supporto regolabile autolivellante  
Adjustable paving support  
self leveling head  
mm 37,5/50

V143

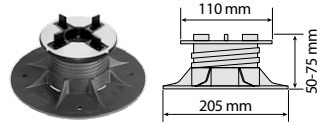

**201003**  
Supporto regolabile autolivellante  
Adjustable paving support  
self leveling head  
mm 50/75

V145

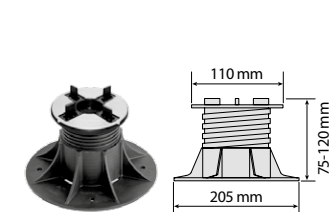

**201004**  
Supporto regolabile autolivellante  
Adjustable paving support  
self leveling head  
mm 75/120

V150

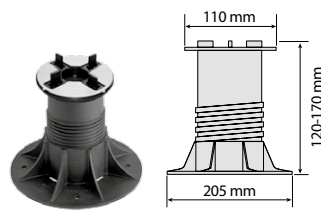

**201005**  
Supporto regolabile autolivellante  
Adjustable paving support  
self leveling head  
mm 120/170

V160

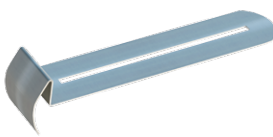

**201015**  
Clip universale per bordo piastra  
Universal edge clip

V110



**201014**  
Chiave di regolazione  
Adjustment key

V383



ATTENZIONE: Per particolari installazioni potrebbero essere necessari articoli ed accessori specifici non presenti in questo catalogo. Per queste esigenze prego riferirsi direttamente al referente commerciale La Fabbrica.

N.B. Particular items and accessories not listed in this catalogue may be required for certain laying methods. For these needs, please contact the La Fabbrica sales directly.

ATTENTION: Pour les installations particulières, certains articles et accessoires particuliers qui ne sont pas indiqués dans ce catalogue pourraient être nécessaires. Dans ces cas-là, nous vous prions de vous référer directement à la référence commerciale La Fabbrica.

ACHTUNG: Für besondere Installationen können besondere Artikel oder Sonderzubehör notwendig sein, die nicht im vorliegenden Katalog aufgeführt sind. Wenden Sie sich bitte in diesen Fällen direkt an den Vertrieb von La Fabbrica.

## IMBALLI

Package . Emballage . Verpackung . Embalajes . Упаковка . 包装

DESCRIZIONE Description Description Beschreibung	PZ. X SCAT. Pieces x Box Stk. x Krt. Pcs / Bte	MQ. X SCAT. Sqm x Box Qm x Krt. M2/ Bte	KG X SCAT. Weight x Box Gewicht x Krt. (kg) Poids / Bte (kg)	EUROPALLET 80x120 cm			Cm. h Pal.
				SCAT. X PAL. Boxes x Pal. Krt. x Pal. Bte / Pal.	MQ. X PAL. Sqm x Pal. Qm x Pal. M2 / Pal.	KG X PAL. Weight x Pal. Gewicht x Pal. (kg) Poids / Pal. (kg)	

### SUPPORTO 15 FISSO

Supporto 15 fisso	200		10,00	20			
LIVELLATORE IN GOMMA 3 mm	500		12,00	70			
LIVELLATORE IN GOMMA 2 mm	600		10,20	70			

### SUPPORTO REGOLABILE

SUPPORTO REGOLABILE mm 25/40	30		6,39	42			
SUPPORTO REGOLABILE mm 40/70	35		9,28	30			
SUPPORTO REGOLABILE mm 60/100	25		8,63	30			
SUPPORTO REGOLABILE mm 90/160	20		8,42	30			

### SUPPORTO REGOLABILE AUTOLIVELLANTE

SUPPORTO REGOLABILE AUTOLIVELLANTE 28/38	50		13,15	30			
SUPPORTO REGOLABILE AUTOLIVELLANTE 37,5/50	40		14,40	30			
SUPPORTO REGOLABILE AUTOLIVELLANTE 50/75	30		10,65	30			
SUPPORTO REGOLABILE AUTOLIVELLANTE 75/120	30		13,80	20			
SUPPORTO REGOLABILE AUTOLIVELLANTE 120/170	25		13,13	20			
Chiave di regolazione	1		0,10				
Clip universale per bordo piastra							

## CERTIFICAZIONI DI PRODOTTO

Product certification . Certification de produit . Produkt Zertifizierungen . Certificaciones de producto . Сертификация . 产品认证

100% DESIGN  
AND PRODUCTION  
OF ITALY



Ceramics of Italy



Certificatione obbligatoria per l'esportazione in Cina  
Certification mandatory for export to China  
Certification obligatoire pour l'exportation en Chine  
Für den Export nach China obligatorische Zertifizierung  
Certificación obligatoria para la exportación a China  
Обязательная сертификация для экспорта в Китай

放射性水平 A类

## ATTENZIONE

Attention . Attention . Warnung . Atención . Внимание . 注意

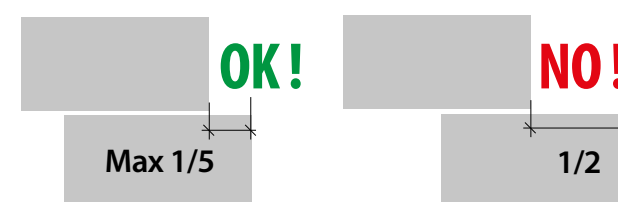

Si consiglia di mantenere una fuga di 2 mm per la posa in monoformato o multiformato degli articoli rettificati.  
Si consiglia di mantenere una fuga di 4 mm per la posa degli articoli con bordi non rettificati.

In the case of straightened-edge tiles, we recommend you keep a 2 mm joint when laying either same sized-tiles or different-sized tiles together. In the case of non-straightened tiles, we recommend you keep a 4 mm joint.

Il est recommandé de maintenir un joint de 2 mm pour la pose en monoformat ou en multiformat des articles rectifiés. Il est recommandé de maintenir un joint de 4 mm pour la pose des articles présentant des bords non rectifiés.

Es wird geraten, eine Fuge von 2 mm bei der Verlegung der geschliffenen Artikel als Einzelformat oder Multiformat einzuhalten. Es wird geraten, eine Fuge von 4 mm bei der Verlegung der Artikel mit ungeschliffenen Rändern einzuhalten.

Se aconseja mantener una junta de 2 mm para la colocación en monoformato o multiformato de los artículos rectificadas. Se aconseja mantener una junta de 4 mm en la colocación de los artículos con bordes no rectificadas.

Рекомендуем оставить шов 2 мм при укладке калиброванной продукции одного или нескольких форматов. Рекомендуем оставить шов 4 мм при укладке продукции с некалиброванными кромками.

建议保留2mm距离以放置单形状或多形状改制物品。建议保留4mm距离以放置带未改制边缘的物品。

# IMBALLI

Package . Emballage . Verpackung . Embalajes . Упаковка . 包装

DESCRIZIONE Description Beschreibung	PZ. X SCAT. Pieces x Box Stk. x Krt. Pcs / Bte	MQ. X SCAT. Sqm x Box Qm x Krt. M² / Bte	KG X SCAT. Weight x Box Gewicht x Krt. (kg) Poids / Bte (kg)	EUROPALLET 80x120 cm			
				SCAT. X PAL. Boxes x Pal. Krt. x Pal. Bte / Pal.	MQ. X PAL. Sqm x Pal. Qm x Pal. M² / Pal.	KG X PAL. Weight x Pal. Gewicht x Pal. (kg) Poids / Pal. (kg)	Cm. h Pal.

## DOLOMITI 10 mm

60x120	2	1,44	33,00	30	43,20	1.010	75
60x60	3	1,08	25,30	40	43,20	1.035	75
30x60	6	1,08	25,06	40	43,20	1.022	75
30,5x60,5	8	1,48	33,65	32	47,36	1.096	75
Mosaico 30x30	6	0,54	13,00	54	29,16	720	75

## STRUTTURATO RETTIFICATO R11 20 mm

40x120	2	0,96	43,01	24	23,04	1.052	75
--------	---	------	-------	----	-------	-------	----

## PEZZI SPECIALI 10 mm

Battiscopa 9,5x60	12		14,50				
Gradino Costa Retta 33x60x3,2	4		23,00				
Gradino Costa Retta Angolo Dx / Sx 33x60x3,2	2		12,00				
Gradino Costa Retta 33x120x3,2	2		23,00				
Gradino Costa Retta Angolo Dx / Sx 33x120x3,2	1		12,00				
Gradino piegato 30,5x34x5 R11	6		15,00				
Elemento a "L" 16x30,5x4,5 R11	6		8,00				

## PEZZI SPECIALI R11 20 mm

Gradone Bordo 40 x120 - Costa retta / Costa toro	1		22,50				
Gradone Bordo ang Dx 40 x120 - Costa retta / Costa toro	1		22,50				
Gradone Bordo ang Sx 40 x120 - Costa retta / Costa toro	1		22,50				
Gradone Bordo Grip 40 x120 - Costa retta / Costa toro	1		22,50				
Gradone Bordo Grip ang Dx 40 x120 - Costa retta / Costa toro	1		22,50				
Gradone Bordo Grip ang Sx 40 x120 - Costa retta / Costa toro	1		22,50				
Gradone Bordo Svasato 40 x120 - Costa retta / Costa toro	1		22,50				
Gradone Bordo Svasato ang Dx 40 x120 - Costa retta / Costa toro	1		22,50				
Gradone Bordo Svasato ang Sx 40 x120 - Costa retta / Costa toro	1		22,50				
Griglia 20 - 20x60	1		6,00				
Griglia 20 - 20x60 Dx	1		6,00				
Griglia 20 - 20x60 Sx	1		6,00				
Canalina 20x120x8h	1		21,00				
Canalina 20x120x8h Dx	1		21,00				
Canalina 20x120x8h Sx	1		21,00				
Cordolo 13x120x13h	1		19,00				
Cordolo 13x120x13h Dx	1		19,00				
Cordolo 13x120x13h Sx	1		19,00				
Bordo L "A" 10x120x10h	1		16,00				
Bordo L "A" 10x120x10h Dx	1		16,00				
Bordo L "A" 10x120x10h Sx	1		16,00				
Bordo L "B" 10x120x10h	1		16,00				
Bordo L "B" 10x120x10h Dx	1		16,00				
Bordo L "B" 10x120x10h Sx	1		16,00				
Alzata 20x120	1		12,00				
Alzata con scuretto 20x120	1		12,00				

I pesi riportati in tabella sono indicativi in quanto possono subire leggere variazioni per motivi produttivi. The weights stated in the chart are approximate as some changes may be necessary for production reasons. Les poids figurant dans le tableau sont fournis à titre indicatif car ils peuvent subir de légères variations pour des raisons de production. Die in der Tabelle aufgeführten Gewichte sind nicht bindend, da sie aus Produktionsgründen leichte Änderungen aufweisen können. Los pesos señalados en la tabla son aproximados ya que pueden experimentar ligeras variaciones por motivos productivos. Указанный в таблице вес является приблизительным, так как ввиду производственных потребностей, он может слегка измениться. 表格记载的重量只具有提示意义, 因为可能在生产过程中产生轻微的偏差。

Il peso dei PEZZI SPECIALI 20 mm indicato in tabella si riferisce al peso del singolo pezzo. Per calcolare il peso complessivo del materiale imballato occorrerà aggiungere al peso in tabella il peso dell'imballo e della palette (peso variabile da 10 a 30 kg in funzione della quantità e della tipologia dei PEZZI SPECIALI richiesti). The weight of the 20 mm TRIMS stated in the table refers to the weight of each trim. To calculate the total weight of the packed material, you will need to add the combined weight of the packing materials and the pallet (weight ranging from 10 to 30kg depending on the quantity and the type of the trims required) to the weight stated in the table. Le poids des PIÈCES SPECIALES 20 mm indique dans le tableau se réfère au poids individuel de chaque pièce. Pour calculer le poids total du matériel emballé, il faudra ajouter au poids indiqué dans le tableau le poids de l'emballage et de la palette (poids variable de 10 à 30 kg en fonction de la quantité et du type de PIÈCES SPECIALES demandées). Das in der Tabelle angegebene Gewicht der 20 mm-SONDERTEILE bezieht sich auf das Gewicht des Einzelteils. Zur Berechnung des Gesamtgewichts des verpackten Materials muss zum in der Tabelle aufgeführten Wert das Gewicht der Verpackung und der Palette (von 10 bis 30 kg variierbar in Abhängigkeit von der Menge und Art der gewünschten SONDERTEILE) dazugerechnet werden.

# CARATTERISTICHE TECNICHE

Technical Features . Caracteristiques Techniques . Technische Eigenschaften . Caracteristicas Tecnicas . Технические Характеристики . 技术特征

GRES PORCELLANATO COLORATO IN MASSA ISO 13006 - G - Bla (E ≤ 0,5%) UNI EN 14411 - G -  
Full-body coloured porcelain stoneware . Grès cérame coloré dans la masse. In der Masse gefärbtes Feinsteinzeug. Gres porcelánico coloreado en masa.  
Окрашенный по всей толщине керамогранит . 多彩陶瓷 - ISO 13006 - G - Bla (E ≤ 0,5%) UNI EN 14411 - G -

CARATTERISTICA SPECIFICATION CARACTERISTIQUE EIGENSCHFT	METODO DI PROVA TEST METHODS METHODE D'ESSAI TESTVERFAHREN	REQUISITI PREVISTI DALLA NORMA REQUIREMENTS IN ACCORDANCE TO THE STANDARDS CARACTERISTIQUES REQUISES VORGESEHENE EIGENSCHAFTEN GEMÄS NORMEN	VALORE MEDIO PORCELLANATO LA FABBRICA LA FABBRICA GLAZED TILES AVERAGE VALUE VALEUR MOYENNE GRES CERAME LA FABBRICA DURCHSCHNITTLICHER WERT GLASIERTES LA FABBRICA		
			NATURALE	RETTIFICATO	LAPPATO RETTIFICATO
<b>CARATTERISTICHE DIMENSIONALI</b> DIMENSIONAL CHARACTERISTICS - DIMENSIONS - DIMENSIONALE EIGENSCHAFTEN					
<b>LUNGHEZZA E LARGHEZZA</b> LENGTH AND WIDTH - LONGUER ET LARGEUR - LÄNGE UND BREITE		± 0,5 %	± 0,3 %	± 0,1 %	± 0,1 %
<b>SPESSORE</b> THICKNESS - EPAISSEUR - STÄRKE	ISO 10545-2	± 5 %	± 4 %	± 4 %	± 4 %
<b>RETTILINEITÀ DEGLI SPIGOLI</b> STRAIGHTNESS OF EDGES - RECTITUDE DES BORDS - RECHTECKIGKEIT DER ECKEN		± 0,5 %	± 0,3 %	± 0,1 %	± 0,1 %
<b>ORTOGONALITÀ</b> ORTHOGONALITY - ORTHOGONALITE - RECHTWINKLIGKEIT		± 0,6 %	± 0,3 %	± 0,1 %	± 0,1 %
<b>PLANARITÀ</b> PLANARITY - PLANARITE - EBENHEIT		± 0,5 %	± 0,3 %	± 0,3 %	± 0,1 %
<b>ASSORBIMENTO D'ACQUA</b> WATER ABSORPTION - ABSORTION D'EAU - WASSERAUFNAHME	ISO 10545-3	≤ 0,5 %	≤ 0,02 %		
<b>RESISTENZA ALLA FLESSIONE</b> BREAKING MODULUS - RESISTANCE A LA FLEXION - BIEGEFESTIGKEIT	ISO 10545-4	35 N/mm² = 356 Kg/cm²	SPESSORE 10 mm	> 35 N/mm²	
<b>SFORZO DI ROTTURA</b> MODULUS OF RUPTURE - CHARGE DE RUPTURE - BRUCHLAST		≥ 7,5 mm: min. 1300 N < 7,5 mm: min. 700 N	SPESSORE 10 mm	> 1300 N	
			SPESSORE 20 mm	16060 N	
<b>DETERMINAZIONE DELLA RESISTENZA A FLESSIONE E CARICO DI ROTTURA</b> DETERMINATION OF BREAKING MODULUS AND MODULUS OF RUPTURE DETERMINATION DE LA RESISTANCE À LA FLEXION ET À LA CHARGE DE RUPTURE BESTIMMUNG DER BIEGEFESTIGKEIT UND DER BRUCHLASTBESTÄNDIGKEIT	UNI EN 1339:2005 / COR. 2011 ANNEX F	<b>SPESSORE</b> - THICKNESS - EPAISSEUR - STÄRKE 20 mm	SPESSORE 20 mm	CLASSE U11	
<b>RESISTENZA ALL'ABRASIONE PROFONDA</b> DEEP ABRASION RESISTANCE - RESISTANCE A L'ABRASION PROFONDE BESTÄNDIGKEIT GEGEN TIEFENVERSCHLEIß	ISO 10545-6	≤ 175 m³	117 m³		
<b>RESISTENZA ALLA ABRASIONE DELLA SUPERFICIE DIPIASTRELLE SMALTATE</b> RESISTANCE TO SURFACE ABRASION OF GLAZED TILES RESISTANCE À L'ABRASION DE LA SURFACE DES CARREAUX ÉMALLÉS WIDERSTAND GEGEN ABRIB DER OBERFLÄCHE DER GLASIERTEN FLIESEN	ISO 10545-7	-	-		
<b>COEFFICIENTE DI DILATAZIONE TERMICA LINEARE</b> THERMAL EXPANSION COEFFICIENT - COEFFICIENT DE DILATATION THERMIQUE LINEAIRE WÄRMEAUDEHNUNGSKOEFFIZIENT	ISO 10545-8	<b>METODO DISPONIBILE</b> AVAILABLE ON REQUEST - METHODE DISPONIBLE VERFÜGBARES VERFAHREN	≤ 7x10 <sup>-6</sup> °C <sup>-1</sup>		
<b>RESISTENZA AGLI SBALZI TERMICI</b> THERMAL SHOCK RESISTANCE - RESISTANCE AUX ECARTS DE TEMPERATURE TEMPERATURWECHSELBESTÄNDIGKEIT	ISO 10545-9	<b>METODO DISPONIBILE</b> AVAILABLE ON REQUEST - METHODE DISPONIBLE VERFÜGBARES VERFAHREN	<b>RESISTENTI</b> RESISTANT - RESISTANTS WIDERSTANDSFÄHIG		
<b>RESISTENZA AL GELO</b> FROST RESISTANCE - RESISTANCE AU GEL - FROSTBESTÄNDIGKEIT	ISO 10545-12	<b>RICHIESTA</b> ALWAYS TESTED - EXIGEE NOTWENDIG	<b>NON GELIVI</b> FROST PROOF - NON GELIFS FROSTSICHER		
<b>RESISTENZA AI PRODOTTI CHIMICI</b> CHEMICAL RESISTANCE - RESISTANCE AUX PRODUITS CHIMIQUES - CHEMISCHE BESTÄNDIGKEIT					
<b>PRODOTTI CHIMICI AD USO DOMESTICO ED ADDITIVI PER PISCINA</b> HOUSEHOLD CHEMICALS AND SWIMMING POOL WATER CLEANSERS PRODUITS CHIMIQUES COURANTS ET ADDITIFS POUR PISCINE CHEM. PRODUKTE FÜR DEN HAUSHALTSGEBRAUCH UND ZUSATZ FÜR SCHWIMMBÄDER	ISO 10545-13	min. UB min. GB	min. UB min. GB		
		<b>DA GLA, GLB A ULC</b> FROM GLA, GLB TO ULC - DE GLA, GLB A ULC VON GLA, GLB BIS ULC	<b>DA GLA, GLB A ULC</b> FROM GLA, GLB TO ULC - DE GLA, GLB A ULC VON GLA, GLB BIS ULC		
		<b>METODO DISPONIBILE</b> AVAILABLE ON REQUEST - METHODE DISPONIBLE VERFÜGBARES VERFAHREN	<b>METODO DISPONIBILE</b> AVAILABLE ON REQUEST - METHODE DISPONIBLE VERFÜGBARES VERFAHREN		
<b>RESISTENZA ALLE MACCHIE</b> STAIN RESISTANCE - RESISTANCE AUX TACHES - FLECKBESTÄNDIGKEIT	ISO 10545-14	<b>METODO DISPONIBILE</b> AVAILABLE ON REQUEST - METHODE DISPONIBLE VERFÜGBARES VERFAHREN	min. 4		
<b>STABILITÀ DEI COLORI ALLA LUCE</b> COLOUR STABILITY TO LIGHT - STABILITE DES COULEURS A LA LUMIERE - LICHTECHTHEIT DER FARBEN	DIN 51094	<b>NON DEVONO PRESENTARE APPREZZABILI VARIAZIONI DI COLORE</b> THEY DO NOT HAVE TO SHOW VISIBLE COLOUR ALTERATION PAS DE MODIFICATIONS SENSIBLES DE COULEUR WEISEN KEINE SICHTBAREN FARBABWEICHUNGEN AUF	<b>CONFORME</b> COMPLIANT CONFORME ERFÜLLT		

Le condizioni generali di vendita, gli schemi ed i consigli di posa sono consultabili sul sito [www.lafabbrica.it](http://www.lafabbrica.it)

The general conditions of sale, together with the laying diagrams and tips are available on the website [www.lafabbrica.it](http://www.lafabbrica.it)

Les conditions générales de vente, les schémas et les conseils de pose peuvent être consultés sur le site [www.lafabbrica.it](http://www.lafabbrica.it)

Die allgemeinen Verkaufsbedingungen, die Schemen und die Verlegeratschläge befinden sich in der Website [www.lafabbrica.it](http://www.lafabbrica.it)

Las condiciones generales de venta, los esquemas y los consejos para la colocación pueden ser consultados en el sitio [www.lafabbrica.it](http://www.lafabbrica.it)

На сайте [www.lafabbrica.it](http://www.lafabbrica.it) вы можете ознакомиться с общими условиями продажи, схемами и рекомендациями по укладке

有关一般销售条件、参数以及安装建议参见网址[www.lafabbrica.it](http://www.lafabbrica.it)

La Fabbrica S.p.A. si riserva di apportare, senza alcun preavviso, le modifiche che riterrà più opportune al fine di migliorare il prodotto. Quanto riportato è da considerarsi indicativo e non esaustivo in riferimento ai colori e alle caratteristiche estetiche dei prodotti.

LA FABBRICA S.p.A. reserves the right to make any changes it deems fit in order to improve the product, without prior notice. All images are provided for illustrative purposes only and other colours and aesthetic features are available.





La Fabbrica S.p.A  
Via Emilia Ponente, 925 - 48014 Castel Bolognese (RA) Italy  
Tel. +39 0546 - 659911 - Fax +39 0546 - 656223  
[www.lafabbrica.it](http://www.lafabbrica.it) - [info@lafabbrica.it](mailto:info@lafabbrica.it)

DAFIN GROUP



[www.avaceramica.it](http://www.avaceramica.it)



[www.lafabbrica.it](http://www.lafabbrica.it)



[www.iblspa.it](http://www.iblspa.it)

Thanks to Gruppo Colombini

Follow us

